

Remote Actuator Unit (RAU) for DD-Frame (D7)

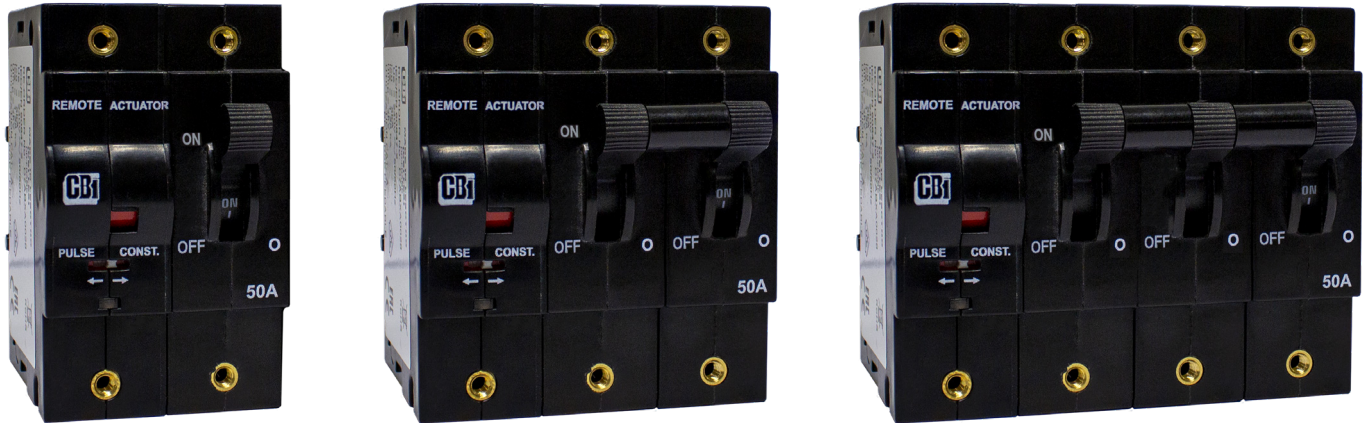

Features

- Remote actuator unit is factory-fitted on the left hand side of the DD-Frame circuit breaker
- The RAU module is designed to function on a wide voltage range: 18 Vdc to 80 Vdc
- **The RAU can be supplied from main system voltage or a standalone source**
- The DD-Frame circuit breaker operates on the main system voltage, AC or DC
- LED for status indication
- Selectable pulse or constant actuate signal operation
- Provides status of the load side of the circuit breaker
- Can be paired with up to a 3 pole DD-Frame circuit breaker state of circuit breaker
- Actuation of circuit breaker occurs internally
- Compact size (19 mm, matching DD-frame outline)

Applications

- Battery management
- Telecommunications
- Railways
- Solar
- System automation
- Switching operations in distant, inconvenient or unreachable environments

The remote actuation unit (RAU) is a factory-fitted module that enables the automated switching of a DD-Frame circuit breaker. The RAU internally actuates the circuit breaker both ON and OFF. The RAU is mounted on the left hand side of the circuit breaker and can actuate up to three poles. The RAU is available with circuit breakers with a standard toggle handle only. The unit has an LED that provides an indication of the mode of operation (PULSE or CONSTANT). A colour flag shows the position of the latch mechanism of the connected circuit breaker - green for OFF and red for ON. The RAU provides the option to set the actuation signal voltage between pulse or constant mode. This is selected by a switch situated on the front of the RAU.

Approvals



(UL489A) (CSA C22.2 No. 5-16)



(CSA C22.2 No. 5-16)



(UL489; CSA C22.2 NO.5)



(UL1077; CSA C22.2 NO.235-04)



(IEC / EN 60947-2; IEC / EN 60934)



(GB14048.2; GB17701)



(IEC 60947-2; IEC 60934)



(IEC 60947-2)

Remote Actuator Unit (RAU) for DD-Frame (D7)

Technical Data

Product Type	RAU		DD Frame
Supply voltage	18 Vdc to 80 Vdc		All values as per DD Frame Circuit Breaker Data Sheet
Actuation signal voltage (For other voltages refer to page 11)	HIGH (ON)	Min. 3.3 Vdc to Max. 60 Vdc	
	LOW (OFF)	Min. 0.0 Vdc to Max. 0.5 Vdc	
Starting current	< 250 mA		
Number of poles that can be actuated	1 to 3 pole DD-Frame - factory fitted		
Ambient operating temperature	-40 °C - +65 °C		
Typical actuation time	OFF state to ON state	2 seconds	
	ON state to OFF state	1 second	
Power consumption	Idle mode	< 250 mW	
	During actuation	< 7.5 W	
Number of operations	In excess of 2000		
Flammability	I3 No flames persistence at 850 °C		
Toxicity	F2 - Smoke index of ≤ 40		
Pollution degree	PD2 - Normally only non-conductive pollution occurs. Temporary conductivity caused by condensation is to be expected.		
Signal Out Resistance to LOAD terminal	330 kΩ ±5% (2 W)		

Product Type	Circuit Breaker	Circuit Breaker	Circuit Breaker	Circuit Breaker
Approvals	IEC / EN 60947-2, GB14048.2, CE, UKCA	IEC / EN 60947-2, GB14048.2, CE, UKCA	IEC60947-2, CE, UKCA	AS/NZS 60947-2, UKCA
Number of Poles	1, 2, 3	2 - 3 (parallel)	1 p, 2p parallel, 3p parallel	1, 2
Maximum Voltages	240 / 415 Vac, 80 Vdc	80 Vdc	60 Vdc	125Vdc
Current Ratings	0.1 - 60 A(ac) 0.1 - 100 A(dc)	110 - 250 A	125 A, 250 A, 300 A	0.1 - 60 A
Ics	5 kA (DC), 1.25kA (AC)	5 kA	2.5kA	2.5kA
Icu	3 kA (AC) 5 kA (AC) 10 kA (DC)	10 kA	5 kA	5 kA

Product Type	Circuit Breaker	Circuit Breaker	Circuit Breaker
Approvals	UL489	UL489 A, CSA C22.2 No. 5-16	UL489A, CSA C22.2 No. 5-16
Number of Poles	1, 2, 3	1, 2, 3	2 - 5 (parallel)
Maximum Voltages	120 Vac, 120 / 240 Vac, 240 Vac, 80 Vdc	60 Vdc	80 Vdc
Current Ratings	0.1 - 80 A(ac) 0.1 - 100 A(dc)	125 A, 250 A, 300 A	110 - 250 A
AIC	AC - 10 kA, DC - 20 kA	14 kA	10 kA

Product Type	Circuit Breaker	Circuit Breaker	Switch	Switch
Approvals	IEC / EN 60934, CE, GB17701	UL1077, cURus	-	-
Number of Poles	1 - 4	1 - 6	-	-
Maximum Voltages	240 / 415 Vac, 80 Vdc	277 / 480 Vac, 80 Vdc	-	-
Current Ratings	0.1 A - 100 A (1 p), 0.1 A - 70 A (2 - 3 p)	.1 A - 100 A (1 p), 0.1 A - 70 A (2 - 4 p)	-	-
Interrupting Capacity	-	2 kA/U2/ U3 (AC) 5 kA/C1 (AC) 5 kAU2/ U3 (DC)	-	-
Rated conditional S/C	3 kA (AC) PC1, 5 kA (DC) PC1	-	-	-
Icm	-	-	-	0.6 kA (for 1 switch)

Verify approvals for specific ratings in accordance with the relevant test certificate

Torque Table

Description	Size	Torque Value
Front Inserts	M3	0.5 - 0.8 N.m
	6 - 32	5 - 7 lbf.in
Rear Studs	M5	2.0 - 2.8 N.m
	10 - 32	18 - 24 lbf.in
	M6	3.5 - 4.0 N.m
	1/4 - 20	30 - 35 lbf.in
Flush Rear Screws	M5	1.7 - 2.3 N.m
	10 - 32	15 - 20 lbf.in

Continues on page 3

Remote Actuator Unit (RAU) for DD-Frame (D7)

Aux Switch Specification	
Gold DB3	EN61058 0.1 A @ 250 Vac & 0.1 A @ 80 Vdc and UL1054 0.1 A @ 125/250 Vac & 0.1 A @ 30 Vdc & 0.3 A @ 60 Vdc
Silver DB2	EN61058 10 A @ 250 Vac & 0.1 A @ 80 Vdc and UL1054 10 A @ 125/250 Vac
Silver V4D	EN61058-1 10 A @ 250 Vac

Ordering Information

Group 1: Frame	Code	Description	Comments					
	D	DD-Frame RAU						
Group 2: Type	Code	Description	Comments					
	7	RAU Non-Lockout type (18 - 80 Vdc) Fitted on Left of Circuit Breaker	RAU D7 + 1 st Circuit Breaker pole					
	2	Additional Circuit Breaker pole	Maximum of 2 additional Circuit Breaker poles					
Group 3: Mounting	Code	Description	Comments					
	A	Front Mount, Rectangular Aperture - Standard Toggle Handle	Maximum penetration depth into the product by the mounting screw is 6mm					
Group 4: Handle Type or Blank for Reduced Handle	Code	Description	Comments					
	A	Standard Toggle Handle	Standard Toggle Handle, goes to Off Position when tripped					
Group 5: Termination	Code	Description	Comments					
	3X	Plug in (Bullet) Terminal (dia 7.8 mm x 16.4 mm)	100 A Max per terminal (80 Vdc) & 125 A Max per terminal (60 Vdc). Ensure the connector has sufficient space so as not to interfere with the terminal bar					
	4X	Flush Rear Screw Terminal, (M5 or 10 - 32)	50 A max per terminal					
	5X	Double Quick Connect Terminal (0.8 mm x 6.35 mm)	50 A Max per terminal					
	AX	Stud Terminals, (M5 or 10 - 32)	60 A Max per terminal					
	MX	Stud Terminals, (M6 or 1/4 - 20)	125 A Max per terminal					
Group 6: Total No. of Poles	Code	Description	Comments					
	2	Two pole – METRIC - RAU + 1 DD Circuit Breaker pole	Two pole modules in total					
	3	Three pole – METRIC - RAU + 2 DD Circuit Breaker poles	Three pole modules in total					
	4	Four pole – METRIC - RAU + 3 DD Circuit Breaker poles	Four pole modules in total					
	B	Two pole – IMPERIAL - RAU + 1 DD Circuit Breaker pole	Two pole modules in total					
	C	Three pole – IMPERIAL - RAU + 2 DD Circuit Breaker poles	Three pole modules in total					
	D	Four pole – IMPERIAL - RAU + 3 DD Circuit Breaker poles	Four pole modules in total					
Group 7: Rated Voltages and Frequency - Main Circuit	Code	Description	Comments					
	H	125Vdc	0.1 A - 60 A Max. (Single pole only)					
	J	120Vac, 240Vac (Applicable to Listed Single Pole DD Frame Circuit Breaker)	Refer to Certificates for Approval details					
	K	240 Vac; 277Vac (Applicable to Recognized Single Pole DD Circuit breaker)	Refer to Certificates for Approval details					
	M	AC & DC Application for Multipole Units (80 Vdc, 240Vac, 240/415 Vac & 277/480 Vac)	Refer to Certificates for Approval details					
	N	80 Vdc	Refer to Certificates for Approval details					
	R	120/240 Vac, 240 Vac, 240/415 Vac; 277/480 Vac (Applicable to Recognized Multipole Products)	Refer to Certificates for Approval details					
	S	120/240 Vac, 240 Vac or 240/415 Vac (Applicable to Listed Multipole Products)	Refer to Certificates for Approval details					
	V	60 Vdc	No Trip Alarm, Mid Trip					
Group 8: Time Delay Characteristics (Pulse Tolerance @ 10 ms)	Code	Description	System	Pulse Tolerance (X In)	Code	Description	System	Pulse Tolerance (X In)
	AD	Long delay 50 / 60 Hz AS & dual rated	AC and DC	8 - 10	CH	Short delay 50 / 60 Hz CS & high inrush	AC	12 - 15
	BD	Medium delay 50 / 60 Hz BS & dual rated	AC and DC	8 - 10	AS	Long delay 50 / 60 Hz	AC or DC	8 - 10
	CD	Short delay 50 / 60 Hz CS & dual rated	AC and DC	6 - 8	BS	Medium delay 50 / 60 Hz	AC or DC	8 - 10
	AE	Long delay 50 / 60 Hz AH & inertia delay	AC	28 - 35	CS	Short delay 50 / 60 Hz	AC or DC	6 - 8
	BE	Medium delay 50 / 60 Hz BH & inertia delay	AC	28 - 35	AW	Long delay 50 / 60 Hz AD & inertia delay	AC and DC	16 - 20
	CE	Short delay 50 / 60 Hz CH & inertia delay	AC	28 - 35	BW	Medium delay 50 / 60 Hz BD & inertia delay	AC and DC	16 - 20
	AI	Long delay 50 / 60 Hz AS & inertia delay	AC or DC	16 - 20	CW	Short delay 50 / 60 Hz CD & inertia delay	AC and DC	12 - 15
	BI	Medium delay 50 / 60 Hz BS & inertia delay	AC or DC	16 - 20	H3	Short delay	DC	6 - 8
	CI	Short delay 50 / 60 Hz CS & inertia delay	AC or DC	12 - 15	OP	Instantaneous trip 50 / 60 Hz	AC or DC	None
	AH	Long delay 50 / 60 Hz AS & high inrush	AC	16 - 20	OX	Switch 50 / 60 Hz	AC and DC	
	BH	Medium delay 50 / 60 Hz BS & high inrush	AC	16 - 20				

Continues on page 4

Remote Actuator Unit (RAU) for DD-Frame (D7)

Ordering Information

Code	Description	Comments
Group 9: Main Circuit Current		
XXXX	No current, for voltage trip poles	Specific Ampere rating possible from 0.1 A to 250 A (80 Vdc) 300 A (60 Vdc)
100M	0.1 A	
0100	1 A	
1000	10 A	
K250	250 A	
Group 10: Circuit Configuration (circuit breaker's internal construction)		
Code Description Comments		
BX	Circuit Breaker (Series Trip Current Sensing)	
KX	Circuit Breaker with Auxiliary Switch	
MX	Circuit Breaker with Trip Alarm, but NO Mid Trip (Reversed Function - Latch Type)	Handle goes to OFF position when tripped and send a Trip Alarm
Group 11: Auxiliary and Alarm Switches Types & Options (Refer to Aux switch specification on page 2)		
Code Description Comments		
A	DB3-Gold Tips, Equally Spaced Terminals, 2.75 mm (0.108") - EN61058 0.1 A @ 250 Vac & 0.1 A @ 80 Vdc and UL1054 0.1 A	
B	DB2-Silver Tips, Equally Spaced Terminals, 2.75mm (0.108") - EN61058 10 A @ 250 Vac & 0.1A @ 80 Vdc and UL1054 10A	
C	V4D - Silver Tips, Offset Terminals, 4.75 mm (0.189") - (10 A @ 250 Vac)	
M	Parallel Bridge Housing - For all Parallel Bridged Poles	Use M for ALL Parallel Bridged Products
X	Not Applicable	
Group 12: Voltage and Current Ratings for Dual Control, Shunt and Relay Trip Construction		
Code Description Comments		
XX	Not applicable	
Group 13: Terminal Options for Dual Control, Shunt and Relay Coils		
Code Description Comments		
X	Not applicable	
Group 14: Future Use		
Code Description Comments		
X	Not applicable	
Group 15: Customer Specific		
Code Description Comments		
X	Not applicable	
S	Customer Specific Product	
Group 16: Handle Colour		
Code Description Comments		
B	Black handle, white marking.	Standard Toggle handle only
W	White handle, black marking	Standard Toggle handle only
Group 17: Handle Markings		
Code Description Comments		
D	I - O/On - Off	
Group 18: Mounting Orientation for Marking		
Code Description Comments		
V	Vertical, Standard Mounting, Line at the Top	
Group 19: Front Plate Marking and Test Button		
Code Description Comments		
A	Standard Marking on Standard Toggle handle	I - O and ON - OFF and ampere rating
Group 20: Inter-phase Barrier and Terminal Cover		
Code Description Comments		
1	Terminal cover(s)	Inter-phase barriers and terminal covers may be required for multi-pole products with UL listed and UL recognised approvals. See DD-Frame Technical Guide.
2	Inter-phase barrier & terminal cover - small	
3	Inter-phase barrier & terminal cover - large	
4	Inter-phase barrier & terminal cover - Z type	
A	Inter-phase barrier - small	
B	Inter-phase barrier - large	
C	Inter-phase barrier - Z type large	
D	Inter-phase barrier - Z type small	
X	Not applicable	
Group 21: Approvals (Product Normally Approved to)		
Code Description Comments		
1	UL recognized UL1077, CUR, IEC/EN60934, CE, UKCA	Normally certified to these specifications
2	UL listed UL489, CUL, IEC/EN60947-2, CE, UKCA	Normally certified to these specifications
3	UL listed UL489A, IEC/EN60947-2, CE, UKCA	Normally certified to these specifications
Group 22: Safety Marks		
Code Description Comments		
X	Not applicable	
C	GB/T 14048.2, CCC	

Verify approvals for specific ratings in accordance with the relevant test certificate

Remote Actuator Unit (RAU) for DD-Frame (D7)

Connection Diagrams

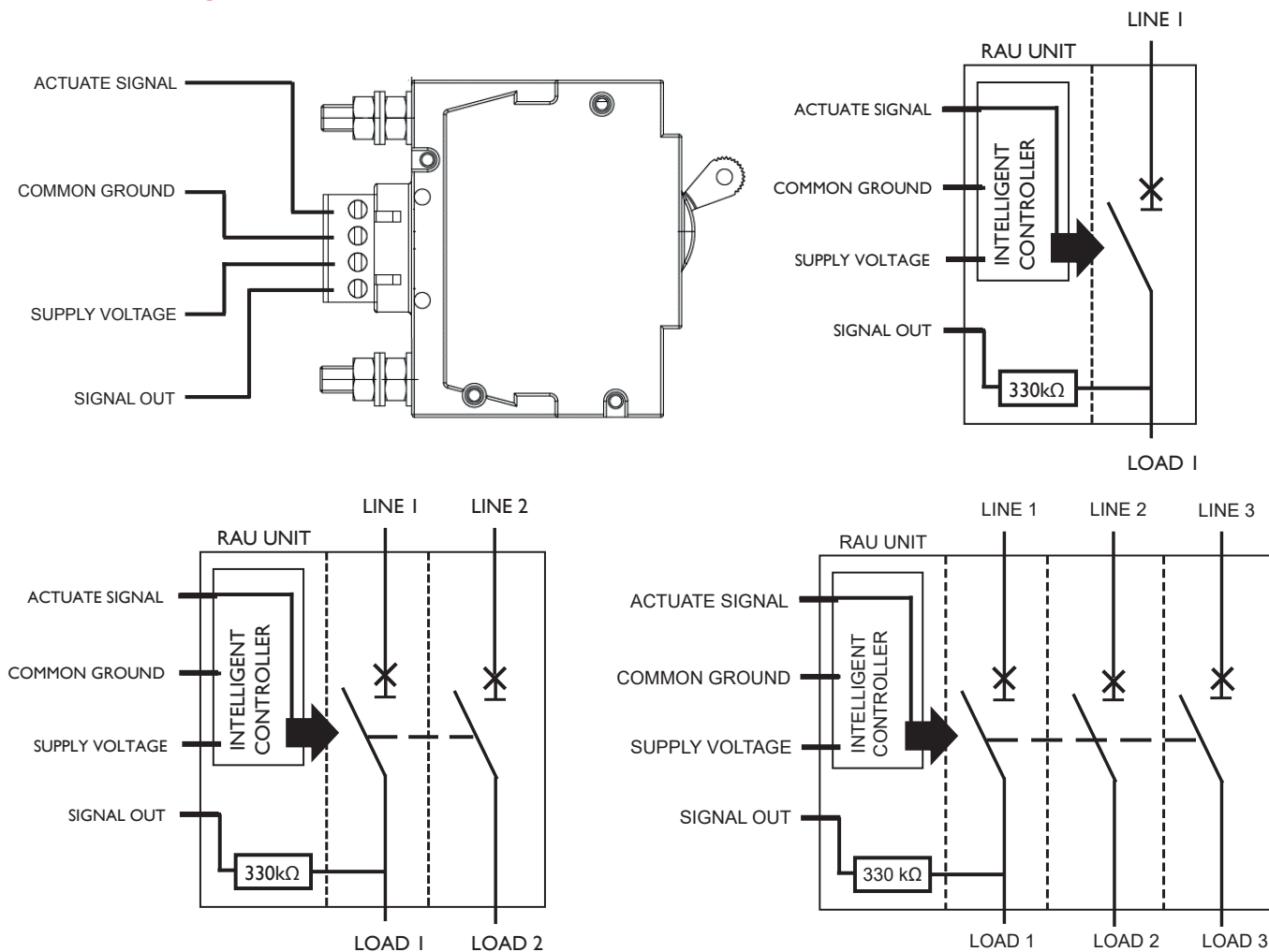

Note: Signal out only provides status indication of the adjacent pole through a 330 kΩ resistor.

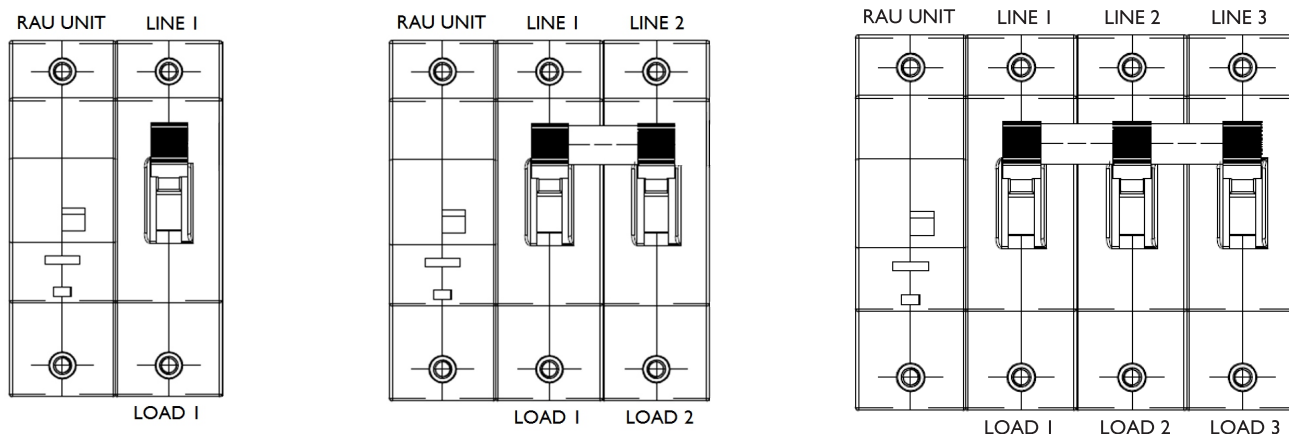

Remote Actuator Unit (RAU) for DD-Frame (D7)

Plug compatible with DEGSON 2EDGKF-5.08-04P -14 and a PHOENIX CONTACT plug 1780002.

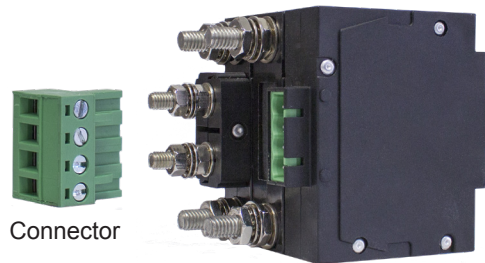

The RAU front switch has two positions, namely "Pulse" or "Constant". Refer to RAU Operation on page 7 for more details.

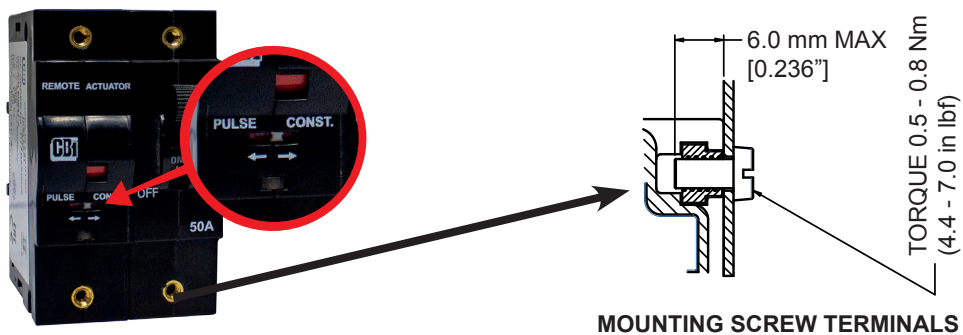

Installation Instructions

1. Before connecting the RAU to power, the circuit breaker must be in the OFF position and the RAU front switch must be set to the user's option of PULSE or CONSTANT.
2. Isolate the power to the circuit breakers.
3. Connect the circuit breakers as required and connect the necessary wiring for the RAU as shown in the connection diagram (page 5).
4. With the circuit breaker in the OFF position, activate the supply to the circuit breakers and the RAU. The LED on the RAU will flash 3 times during its initialisation process.

Remote Actuator Unit (RAU) for DD-Frame (D7)

The RAU Operation

1. RAU initial conditions

- RAU in OFF position
- Actuation signal OFF
- Supply voltage ON
- LED flashes 3 times
- RAU manual operation possible

2. Operations in PULSE mode (The LED is ON)

- Apply a pulse signal, the RAU will actuate ON
- Apply another the pulse signal, the RAU will actuate to the OFF position

3. Operations in CONSTANT mode (The LED is always OFF)

- Apply a constant signal, the RAU will actuate ON
- Remove the constant signal and the RAU will switch OFF

4. Changing Mode

Use a small tool to slide the front switch between CONSTANT and PULSE modes. The LED state will confirm the selection

Note: when moving the front switch from PULSE mode to CONSTANT mode while powered, may cause the breaker to inadvertently switch off, due to the signal level being low

5. Relatching

To relatch after an overcurrent trip, send a signal to turn off and back on again

NOTE:

- **DO NOT** move or block the circuit breaker handles while the RAU is actuating remotely.
- **DO NOT** change the state of the actuate signal or RAU front switch rapidly, or while the circuit breaker is in motion, allow at least a 3 seconds waiting period before changing the state.

Remote Actuator Unit (RAU) for DD-Frame (D7)

LED Status Indication Confirmation

LED State	Indication
Flash 3 times	Initialisation
Flash 3 times every 4 seconds	Fault state
ON	Pulse actuation signal mode
OFF	Constant actuation signal mode
2 Short flash & 1 long flash	Initialisation fault

Application Notes:

RAU powered from Negative DC Bus

The DD-frame RAU requires a positive supply voltage between 18 Vdc and 80 Vdc to operate, however, systems may only have a negative voltage supply available. The RAU is able to accommodate such environments. Figure 1 shows an example of an RAU in a telecommunications application which only has a -48 Vdc bus voltage available. Resistor R is required if the potential difference between the Actuate Signal pin and the Common pin is greater than 60 Vdc.

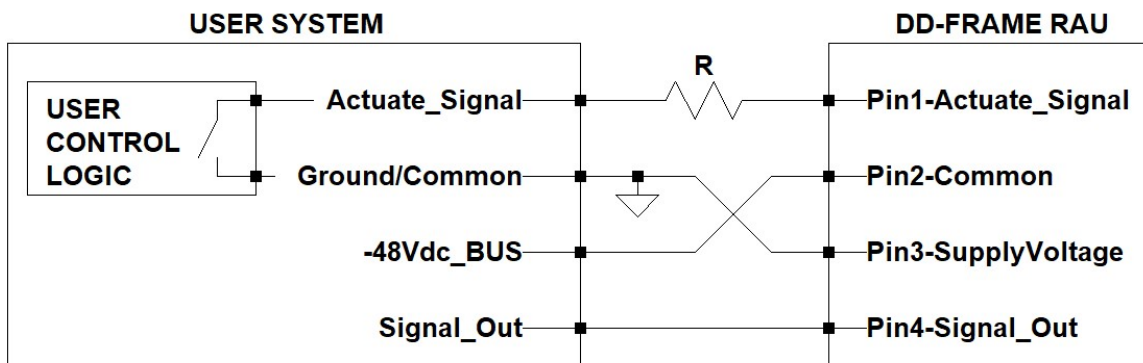

Figure 1: Wiring diagram example for DD-Frame RAU powered from negative supply bus in a -48 Vdc telecommunications application

Remote Actuator Unit (RAU) for DD-Frame (D7)

Using the Signal Out

Signal out can have many functions and is not just an auxiliary contact to indicate the open / closed state of the circuit breaker. The signal out function will depend on its specific application. This application note will convey the function of signal out for various applications under resistive loads only.

The signal out contact is connected only to the adjacent pole LOAD side and is isolated from the control.

Note that the signal out will vary depending on the type of load and will need to be taken into consideration when designing the RAU into a system.

Table 2: Wiring Configuration

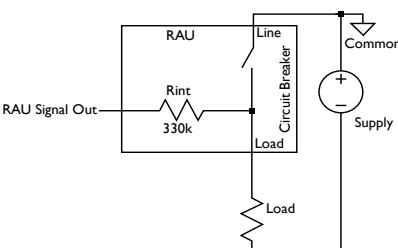
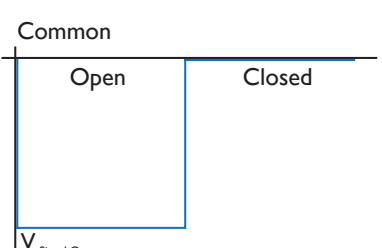
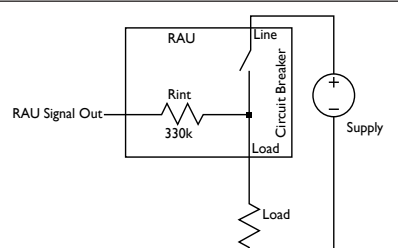
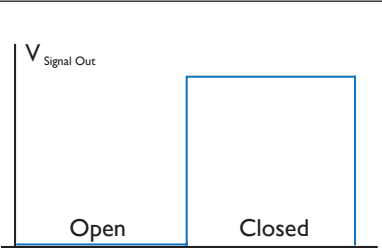
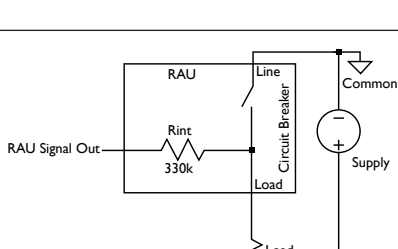
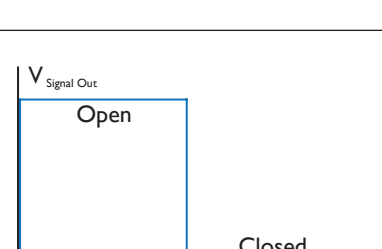
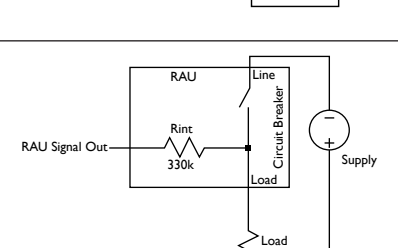
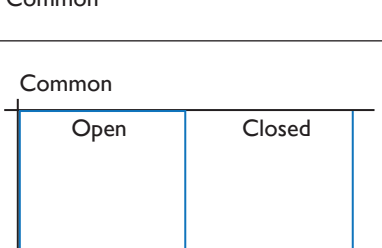
Wiring Configuration	Signal Out with reference to common when circuit breaker is open or closed	Purpose of Signal out
		Monitor status of circuit breaker
		Monitor status of circuit breaker
		Monitor status of circuit breaker
		Monitor status of circuit breaker

Remote Actuator Unit (RAU) for DD-Frame (D7)

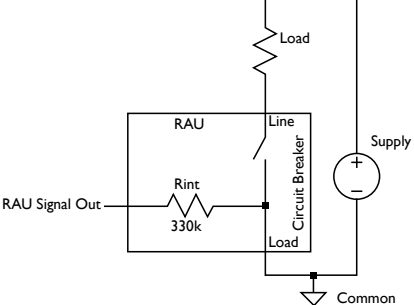
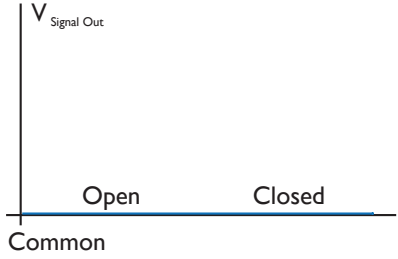
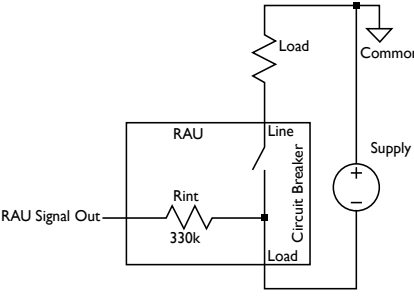
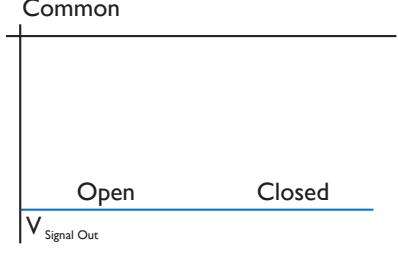
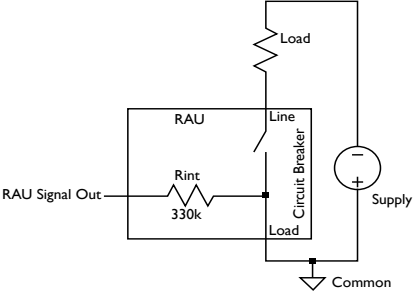
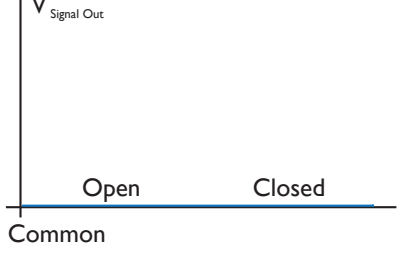
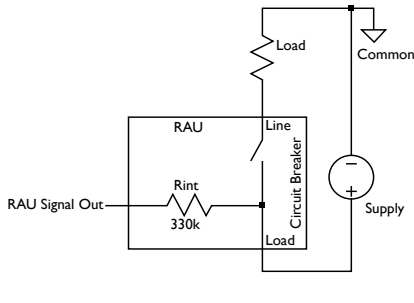
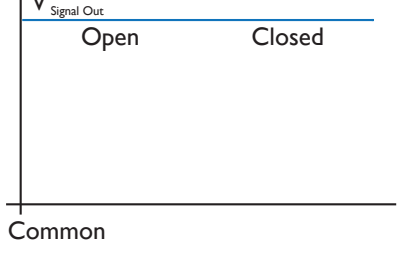
Wiring Configuration	Signal Out with reference to RAU Common	Purpose of Signal out
		Common potential monitoring
		Monitor Supply
		Common potential monitoring
		Monitor supply

Remote Actuator Unit (RAU) for DD-Frame (D7)

Actuation Signal Voltage Greater than 60 Vdc

The maximum actuation signal voltage that can be applied to the DD-Frame RAU is 60 Vdc. If the application is such that the actuation signal voltage will be larger than 60 Vdc, then an external resistor must be added in series as indicated in figure 2.

The value of the resistor can be designed for using the following equation:

$$R = \left(\frac{V_{\text{supply}} - 60}{0.001} \right) \text{ with deviation of } \pm 20\%$$

For example, if the actuation signal voltage will be 72 Vdc, then a 12 kΩ resistor must be added in series. See table 3.

External resistor to add in series for actuation signal voltage above

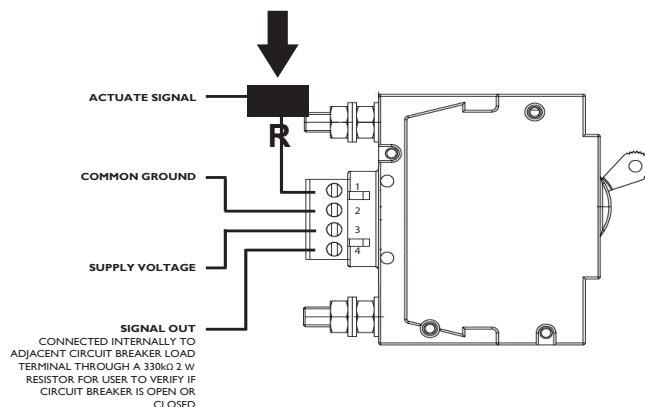

Figure 2: Side view of DD-Frame RAU indicating how to add resistor in series for actuation signal voltages above 60 Vdc

Table 3: Actuation signal voltages and corresponding resistor values to be added in series

Actuation Voltages in Volts dc	External resistor to add in series with actuate terminal (E12 series)
72	12 kΩ
80	22 kΩ

Alternatively, a voltage divider may be implemented to create a signal voltage between 5 Vdc and 60 Vdc. The minimum current required by the actuation signal input is 5 mA.

Dimensional Drawings

